

GNY EQUIPMENT, LLC.
 20 DREXEL DRIVE,
 BAY SHORE, NY 11706
 U.S.A.
 gnyequip@gnyequipment.com
 www.gnyequipment.com

**GNY SUCTION LINE
 FLOATATION INDICATOR
 GNY MODEL 6534013**

SKETCH NO. :
 GNY 6534013
 Rev. : 0
 Sheet 1 of 3
 Date : 02/28/2007

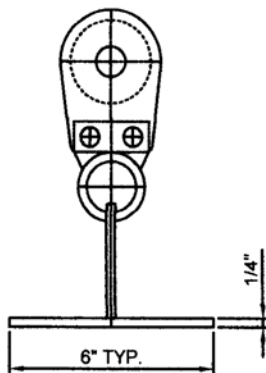
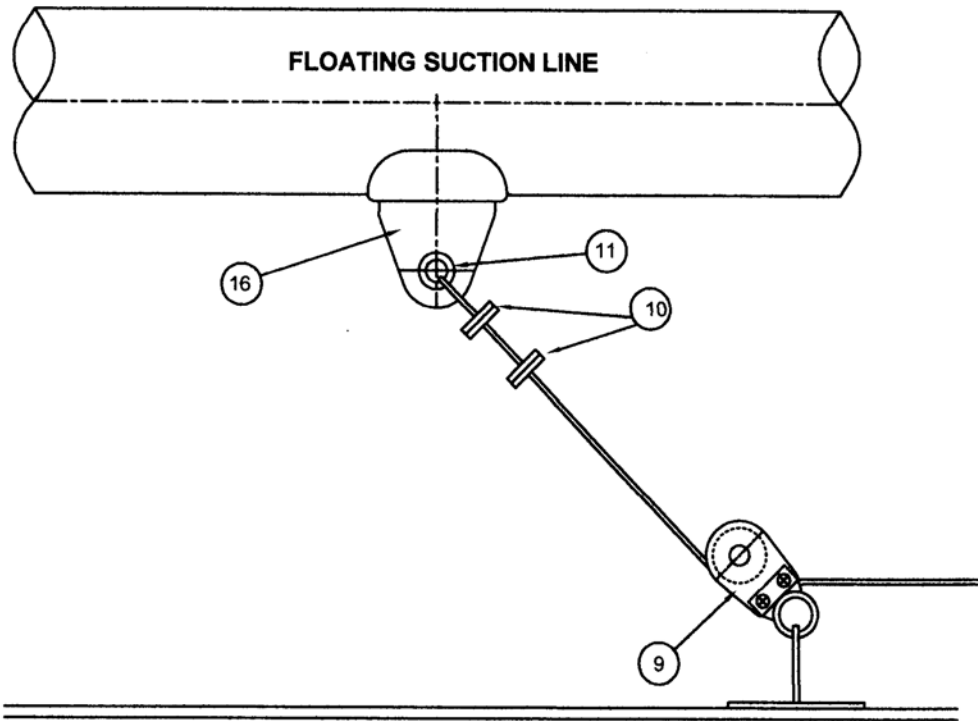

ELEVATION

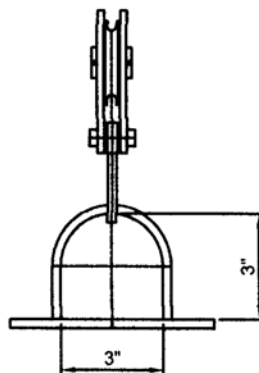

SIDE VIEW

DETAIL ITEM NO. 9

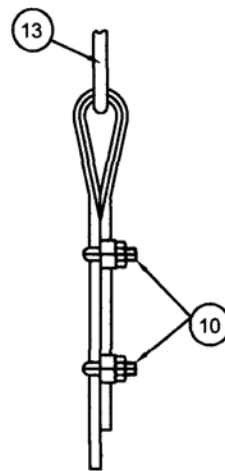

DETAIL ITEM NO. 10

GN Y EQUIPMENT, LLC.
 20 DREXEL DRIVE,
 BAY SHORE, NY 11706
 U.S.A.
 gnyequip@gnyequipment.com
 www.gnyequipment.com

**GN Y SUCTION LINE
 FLOATATION INDICATOR
 GN Y MODEL 6534013**

SKETCH NO. :
 GN Y 6534013
 Rev. : 0
 Sheet 2 of 3
 Date : 02/28/2007

GNY MODEL GNY6534013 SUCTION LINE FLOATATION INDICATOR

PARTS LIST

ITEM NO.	QUANTITY	DESCRIPTION	MATERIAL
1	2	SHEAVE EL. ASSY. 90D	T-316 SS, 18-8 WHEEL/TEFLON BEARING
2	1	1 1/2" PIPE NIPPLE X 6"	T-304 SS
3	1	1 1/2" PIPE NIPPLE X 22"	T-304 SS
4	1	1 1/2" PIPE NIPPLE X 17 5/16"	T-304 SS
5	1	1 1/2" PIPE NIPPLE X 12"	T-304 SS
6	1	TOP BRACKET ASSY	CARBON STEEL-PRIME PAINTED. FINSH COAT AFTER WELDING TO TANK BY OTHERS.
7	1	BOTTOM BRACKET ASSY	CARBON STEEL-PRIME PAINTED. FINSH COAT AFTER WELDING TO TANK BY OTHERS.
8	1	INDICATOR TARGET	TARGET IS CARBON STEEL EPOXY COATED.
9	2	SWIVEL BLOCK/WELD PAD	SS BLOCK W/ NYLON WHEEL. WELD PAD IS 1/4" H.R.STL.
10	6	WIRE ROPE CLIP/THIMBLE KIT	SS
11	2	ANCHOR SHACKLE	SS
12	1	1 1/2" FPT UNION	T-304 SS
13	4	EYEBOLT 3/8"-16	T-304 SS
14	2	3/16" WIRE ROPE 7 X 19	SS (GUIDE WIRES X TANK HT. IN LNGTH)
15	1	1 1/2" FPT FULL COUPLING	T-304 SS
16	1	CABLE ATTACHMENT LUG	WELDED TO PIPE BY GNY. SAME MAT'L. AS SUCTION PIPE.
17	A/R	3/16" WIRE ROPE 7 X 19	SS (QUANTITY VARIES WITH TANK HT.)
18	1	INSTALLATION INSTRUCTIONS	

GNY EQUIPMENT, LLC.
20 DREXEL DRIVE,
BAY SHORE, NY 11706
U.S.A.
gnyequip@gnyequipment.com
www.gnyequipment.com

**GNY SUCTION LINE
FLOATATION INDICATOR
GNY MODEL 6534013**

SKETCH NO. :
GNY 6534013
Rev. : 0
Sheet 3 of 3
Date : 02/28/2007

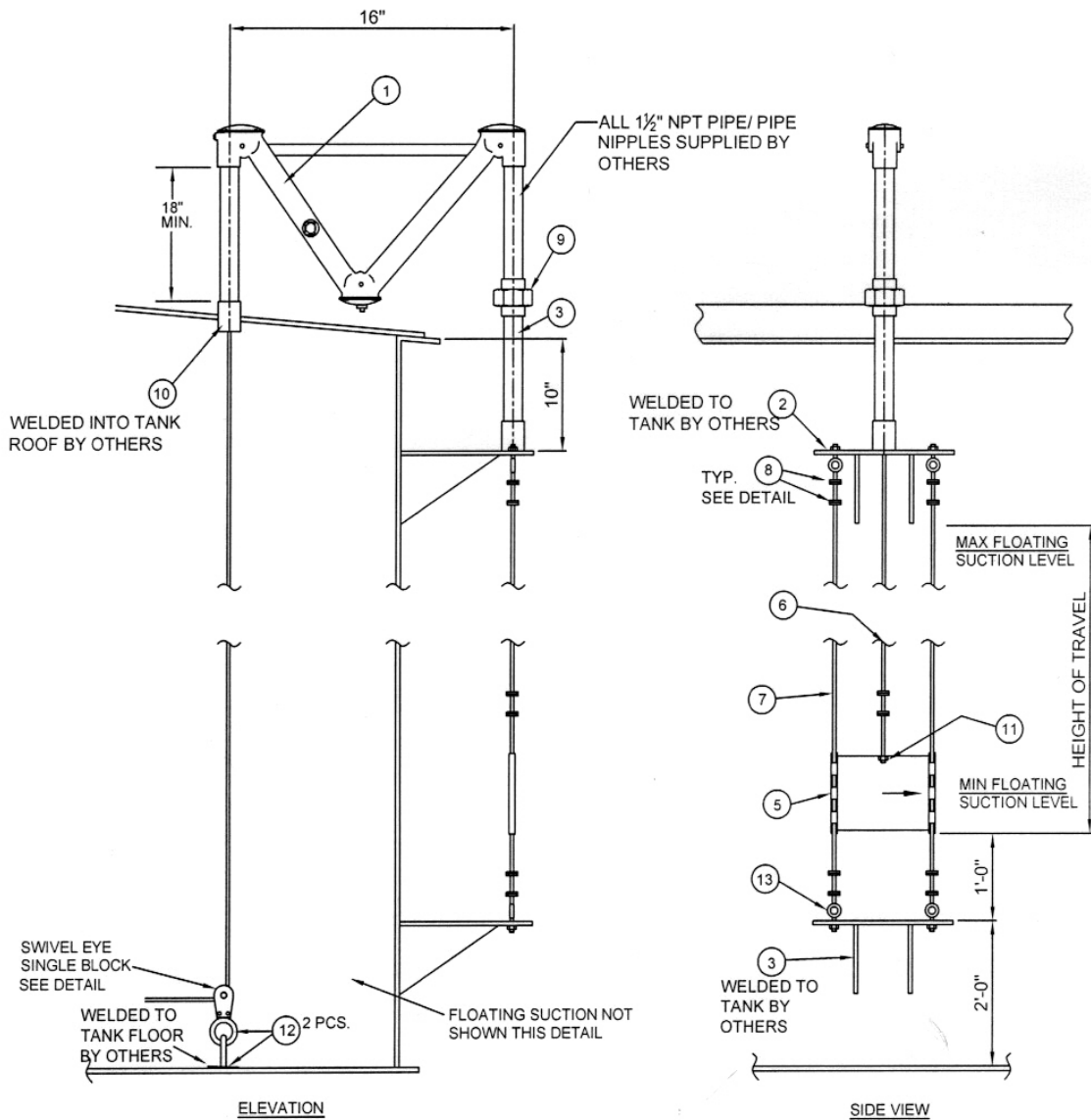

GNY EQUIPMENT, LLC.
 20 DREXEL DRIVE,
 BAY SHORE, NY 11706
 U.S.A.
 gnyequip@gnyequipment.com
 www.gnyequipment.com

GNY SUCTION LINE
FLOATATION INDICATOR W/ LIQUID SEAL
GNY MODEL 6534013-L

SKETCH NO. :
 GNY 6534013-L
 Rev. : 0
 Sheet 1 of 3
 Date : 07/08/2009

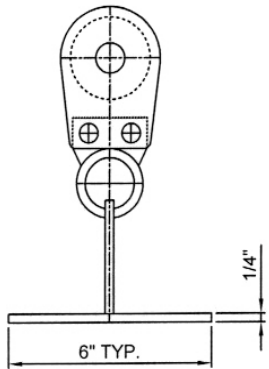
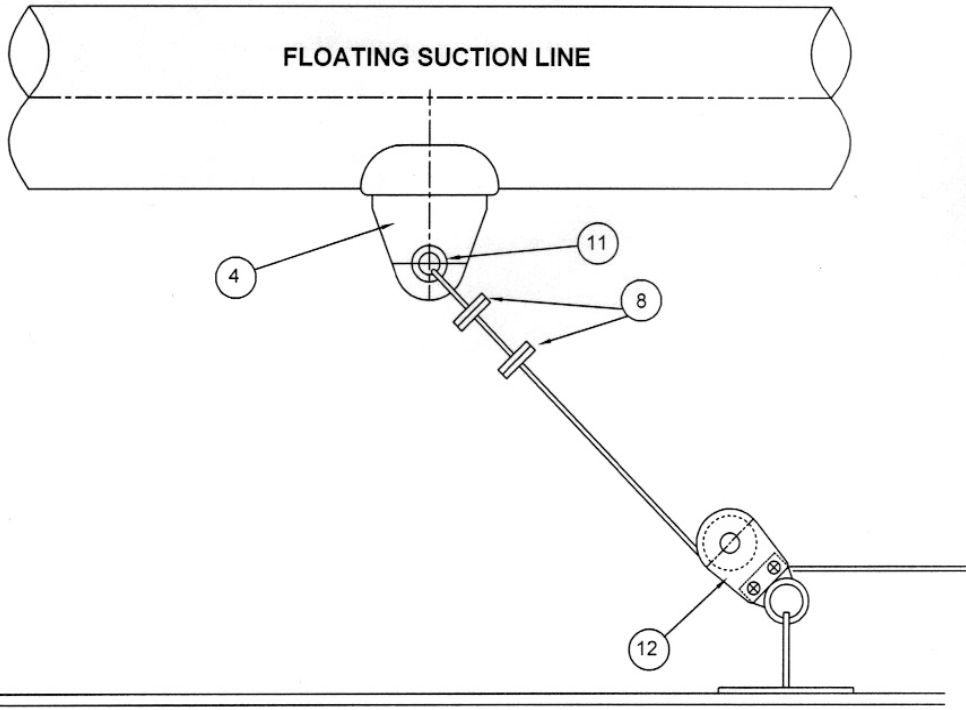

ELEVATION

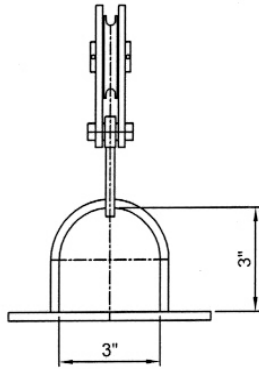

SIDE VIEW

DETAIL ITEM NO. 12

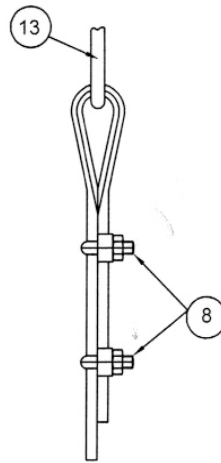

DETAIL ITEM NO. 8

GNY EQUIPMENT, LLC.
 20 DREXEL DRIVE,
 BAY SHORE, NY 11706
 U.S.A.
 gnyequip@gnyequipment.com
 www.gnyequipment.com

**GNY SUCTION LINE
 FLOATATION INDICATOR W/ LIQUID SEAL
 GNY MODEL 6534013-L**

SKETCH NO. :
 GNY 6534013-L
 Rev. : 0
 Sheet 2 of 3
 Date : 07/08/2009

PARTS LIST

ITEM NO.	QUANTITY	DESCRIPTION	MATERIAL
1	1	LIQUID SEAL ASSY.	ALUM. HOUSING, 18-8 WHEELS & TEFLON BEARINGS.
2	1	TOP BRKT. ASSY.	C.S. PRIME PAINTED.
3	3	BOTT. BRKT. ASSY.	C.S. PRIME PAINTED.
4	1	CABLE ATTACHMNT. LUG	WELDED TO PIPE BY GNY SAME MAT'L AS SUCT. PIPE
5	1	INDICATOR TARGET	C.S. EPOXY COATED.
6	A/R	CABLE 3/16"	STAINLESS STEEL
7	2	CABLE 3/16"	STAINLESS STEEL
8	6	WIRE ROPE CLIP	STAINLESS STEEL
9	1	1 1/2" FPT UNION	STAINLESS STEEL
10	1	1 1/2" FPT FULL COUPLING	C.S.
11	2	ANCHOR SHACKLE	STAINLESS STEEL
12	2	SWIVEL BLOCK/ WELD PAD	SS BLOCK W/ NYLON WHEEL. PAD 1/4" C.S.
13	4	EYEBOLT 3/8"-16	STAINLESS STEEL
14	1	INSTALLATION INSTRUCTIONS	

GNY EQUIPMENT, LLC.
 20 DREXEL DRIVE,
 BAY SHORE, NY 11706
 U.S.A.
 gnyequip@gnyequipment.com
 www.gnyequipment.com

**GNY SUCTION LINE
 FLOATATION INDICATOR W/ LIQUID SEAL
 GNY MODEL 6534013-L**

SKETCH NO. :
 GNY 6534013-L
 Rev. : 0
 Sheet 3 of 3
 Date : 07/08/2009